

Are you trying to shape your world ergonomically?

Or trying to reclaim valuable desk space? With our patented Quick Release installation is always simple:

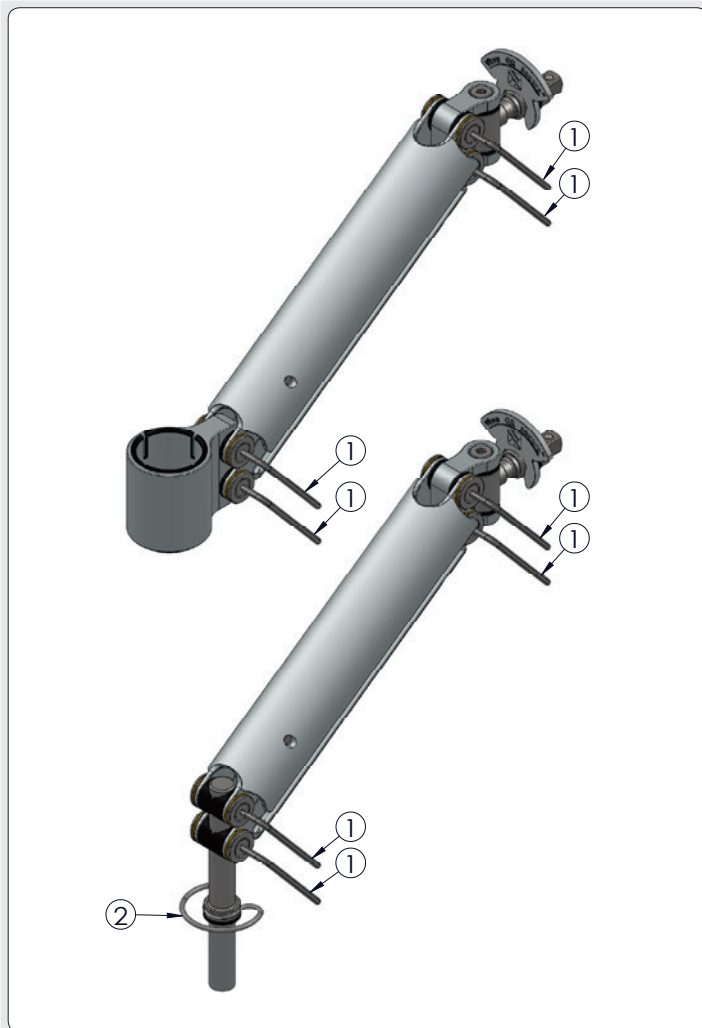

**First**, attach VESA Quick Release Ball Joint - *female* (V012 VESA QR) to the monitor. Use Hex Key 2.5 mm.

**Warning:** it may not be possible to completely insert included fasteners to securely fasten VESA and monitor. If fasteners are inserted too deep, the monitor may get damaged.

Vlaar International will not accept any liability for poor performance caused by installation using inappropriate and incompatible materials. In addition, Vlaar International accepts no liability in relation to the performance of any (included) fastener.

**Next**, connect your monitor to the Arm.

- Slide VESA Quick Release Ball Joint - *female* (V012 VESA QR) over Arm's Quick Release Joint - *male*.
- To lock, depress Arm's Quick Release Tab and slide monitor towards Arm until it stops. Release Tab. **Make sure the connection is secure.**
- To release, depress Quick Release Tab again and slide monitor away from Arm.

**Finally**, adjust friction.

If your monitor is particularly heavy, or after prolonged use, VESA Quick Release Ball Joint - *female* (V012 VESA QR) may require increased friction. This can be achieved by tightening the 3 Ball Joint Friction Screws using Hex Key 2.5 mm.

**Be sure to apply the same amount of rotation to each screw.**

1. Your monitor should move up and down easily and stay in place once adjusted. If it is difficult to adjust or it moves without assistance, it is not properly counterbalanced. Use Hex Key 3 mm to increase height adjustment friction by tightening the 4 Friction Joint Screws.

**Be sure to apply the same amount of rotation to each screw.**

2. Our Arms include cable management clips to keep monitor cables organized and protected.

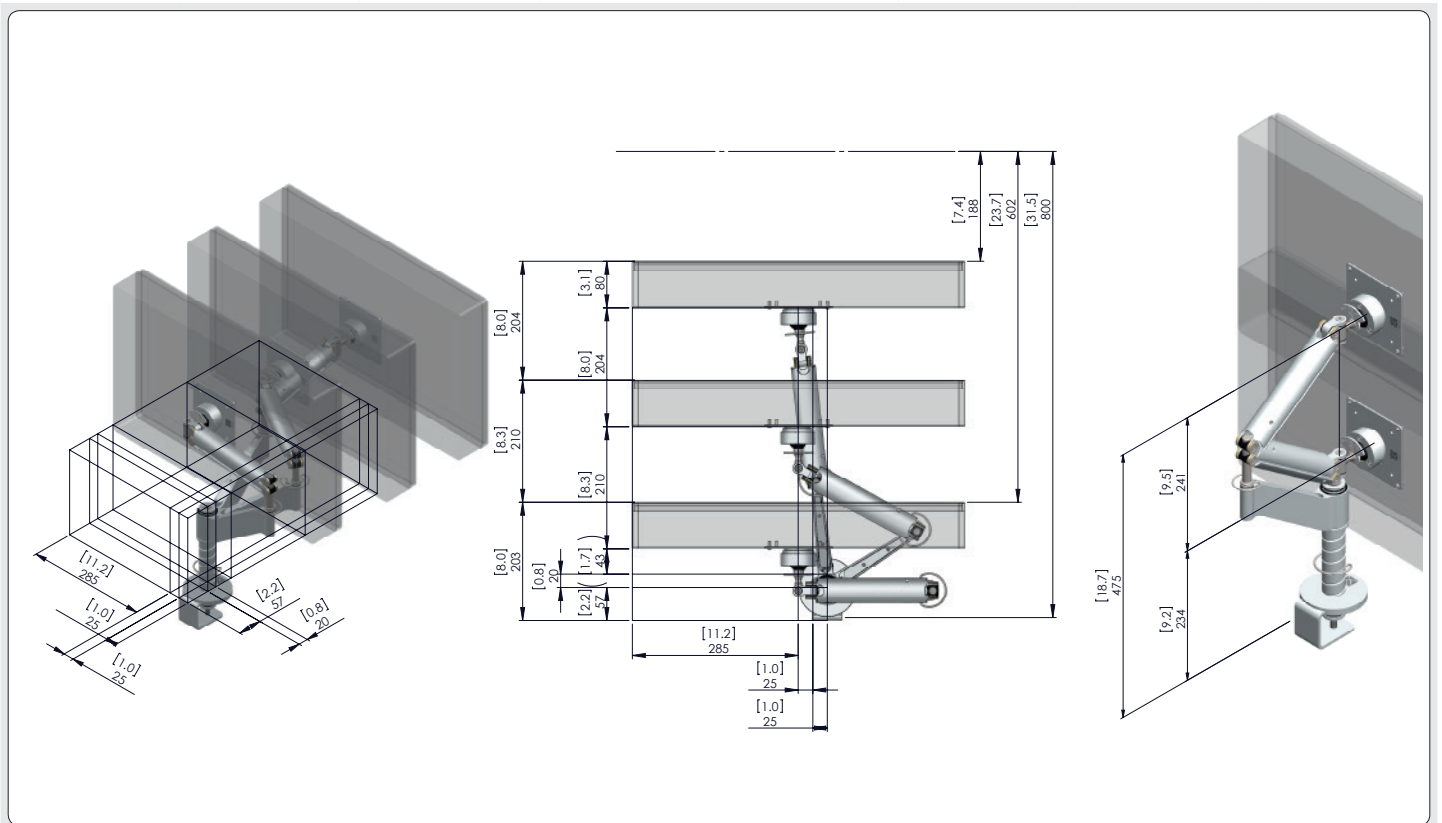

Caparo Series

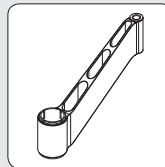

V312

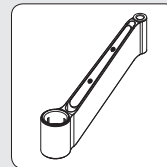

V322

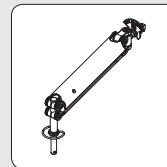

V310

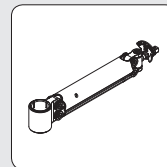

V422

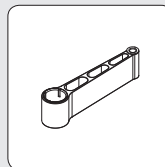

V424

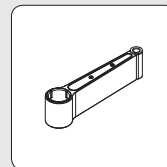

V426

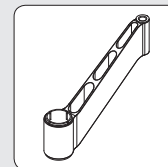

V312

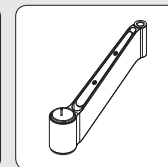

V430

Tacoma Series

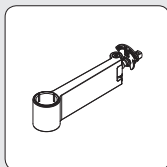

V412

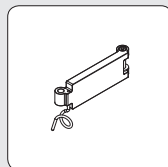

V418

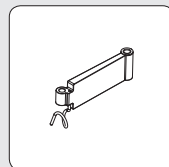

V432

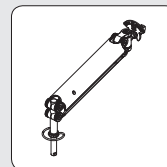

V310



**VLAAR INTERNATIONAL**  
I N N O V A T E I T

info@vlaar.com | [www.vlaar.com](http://www.vlaar.com)

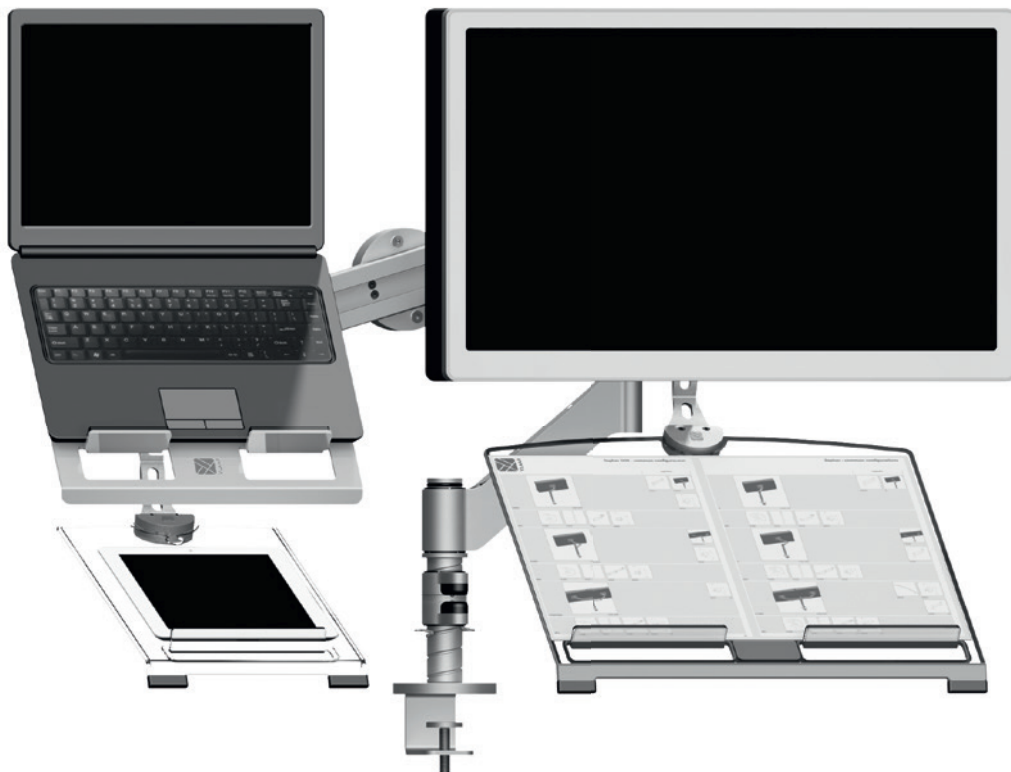

All registered designs, registered trademarks, registered patents and © Vlaar International.

The information and advice contained in these instructions is of a general nature only and has not been prepared with your specific needs in mind. You should always obtain specialist advice to ensure that the materials, approach and techniques referred to in these instructions meet your specific requirements.

Vlaar International makes no warranty as to the accuracy, completeness or reliability of any estimates, opinions or other information contained in these instructions and to the maximum extent permitted by law, Vlaar International disclaims all liability and responsibility for any loss or damage, direct or indirect, which may be suffered by any person acting in reliance on anything contained in or omitted from these instructions.

All rights reserved.